

To whom it may concern

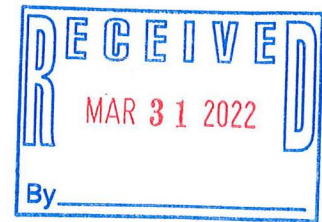

I am requesting an aera variance to construct a 15 x 16 paver patio and a gazebo style roof over the patio in my back yard. I am requesting to place this patio about 2 feet off the rear lot line of my property this is due to the way the house sits on the lot and there being no back yard as the house sits about 14 feet off the rear lot line. The location I am requesting to place the patio I have chosen as I feel it has the least impact on the affected neighbor and places it as far from their house as possible, I have also spoken with the affected neighbor, and they don't have any issues with this project. The patio will be in my fenced in back / side yard and the only part of the project that will be visible from outside the fence will be the roof over the patio

Thank you

Michale boccuzzi

55 hilltop drive

Penfield NY 14526



RECEIVED
MAR 31 2022
By _____

15X15 PAVILION

© MyOutdoorPlans.com



SCANNED
Sold to
mboccuzzi106@gmail.com

mboccuzzi106@gmail.com

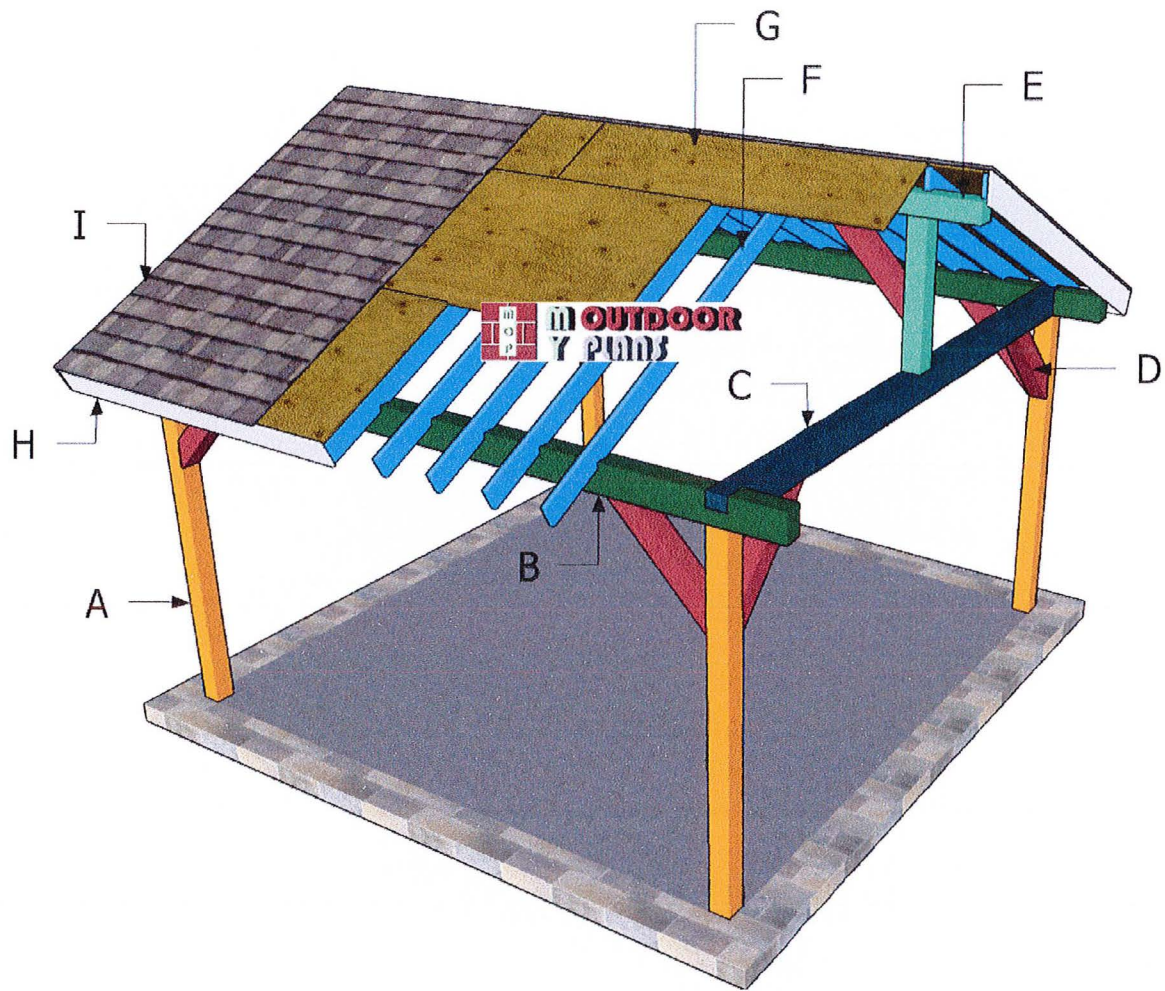

MORE PLANS AT:

MYOUTDOORPLANS.COM/SHOP

MATERIALS LIST

PIECES

6x6 lumber - 8' long	4 pieces
6x6 lumber - 12' long	3 pieces
6x8 lumber - 18' long	3 pieces
6x8 lumber - 16' long	2 pieces
2x6 lumber - 10' long	28 pieces
1x8 lumber - 8' long	2 pieces
1x8 lumber - 10' long	2 pieces
1x8 lumber - 12' long	4 pieces
3/4" plywood - 4'x8'	11 pieces
Tar Paper & Asphalt Shingles	400 sq ft
6x6 Post Anchors	4 pieces
Concrete	Several Bags
Stain	4 cans
Post to Beam Connector	4 pieces
Rafter ties	56 pieces
1 5/8" screws	800 pieces
8" screws	8 pieces
10" screws	8 pieces
5 1/2" screws	50 pieces
2" nails	200 pieces
1 1/2" structural screws	2 boxes
2 1/2" structural screws	1 box
Drip edge	80 ft
Staples for tar paper	1000 pieces
3/4" Roofing Nails	1000 pieces



CUT LIST

PIECES

A - Posts - 6x6 lumber 8' long	4 pieces
B - Plates - 6x8 lumber 208" long	2 pieces
C - Plates - 6x8 lumber 15' long	2 pieces
D - Braces - 6x6 lumber 36" long	10 pieces
E - Supports - 6x6 lumber 36 1/2" long	2 pieces
E - Ridge Beam - 6x8 lumber 208" long	1 piece
F - Rafters - 2x6 lumber 10' long	28 pieces
H - Roof - 3/4" plywood 4'x8'	6 pieces
H - Roof - 3/4" plywood 4'x4'	2 pieces
H - Roof - 3/4" plywood 2" x8'	4 pieces
H - Roof - 3/4" plywood 4'x64"	2 pieces
H - Roof - 3/4" plywood 16"x2'	2 pieces
H - Roof - 3/4" plywood 16"x4'	2 pieces
H - Trims - 1x8 lumber 112" long	2 pieces
H - Trims - 1x8 lumber 96" long	2 pieces
H - Trims - 1x8 lumber 121 1/4" long	4 pieces
I - Roofing - Tar paper & Asphalt Shingles	400 sq ft

Tools

- Miter Saw
- Drill
- Orbital Sander
- Wheelbarrow, Shovel
- Spirit level
- Tape Measure, Pencil, Square, Brush
- Safety Glasses, Hearing Protection

Time

- 1 week

Cost Estimate

- \$1800

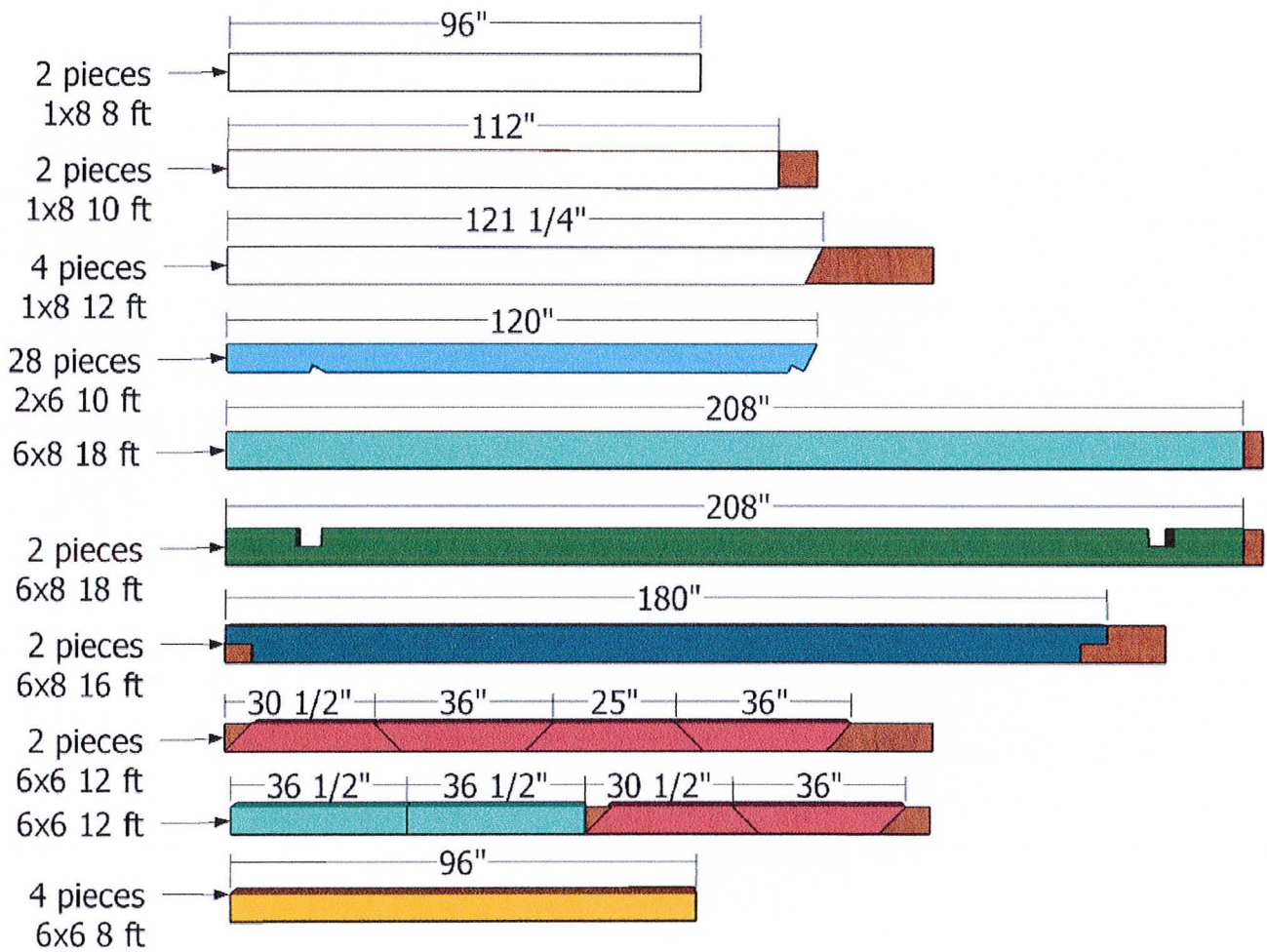

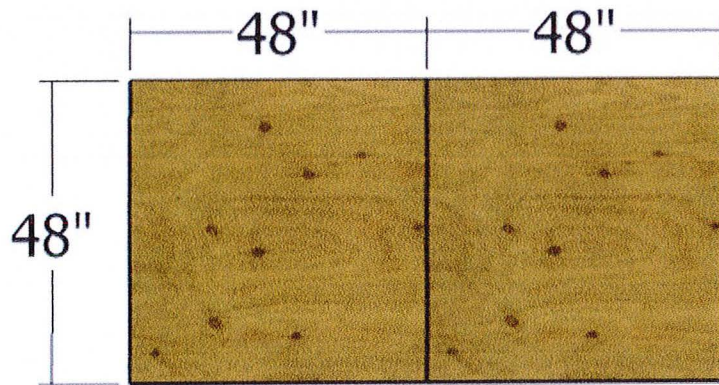
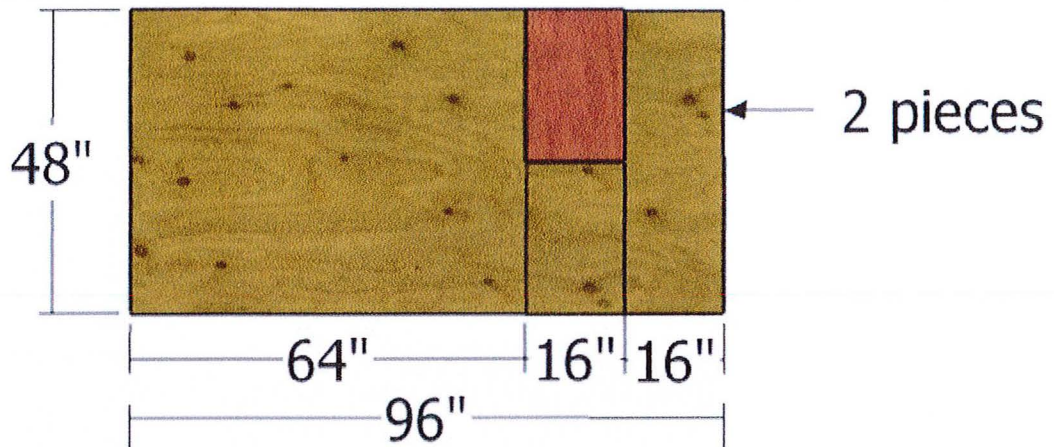

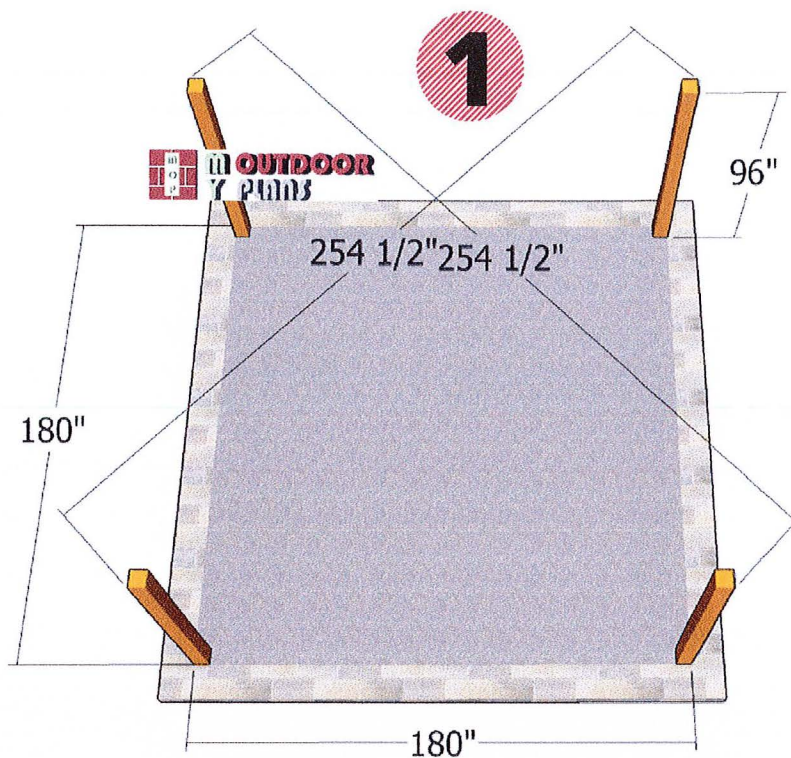

First, layout the posts for the 15×15 pavilion. Use batter boards and string to determine the location of the posts. Apply the 3-4-5 rule to every corner of the pavilion, so you make sure they are right angled. Make sure the diagonals are equal. Determining the location for the pavilion is essential, as you have to comply with the local building codes. Make sure the surface is level and remove the vegetation layer.

2

Dig 3 ft holes into the ground, making sure they have about 16" in diameter. Fit the tubes then the posts into the ground and plumb them with a spirit level. Fill the holes with concrete and insert the anchors. Let the concrete dry out for several days.

Read the local codes for more details on how to secure the posts.

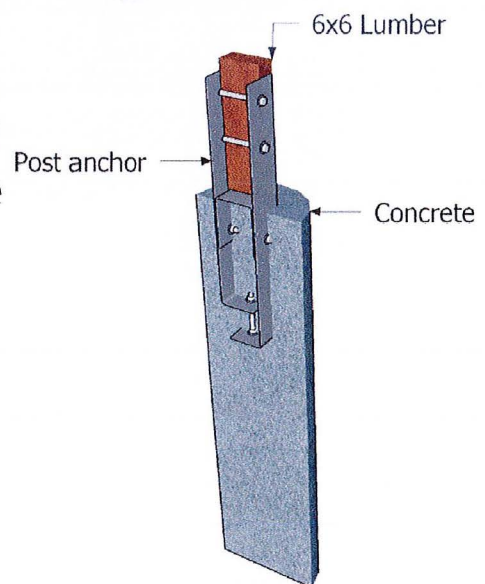

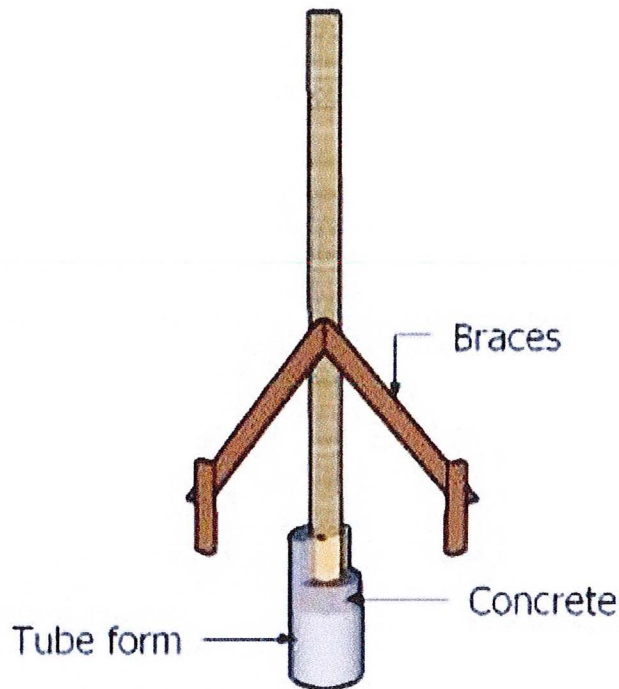

Use lag screws to secure the posts to the anchors. Before pouring the concrete you need to make sure the top of the posts are horizontal one to another. Use a laser to mark the level to the top of the posts and use a circular saw, if you need to make cuts. Use 2x4 braces to lock the posts temporarily into place tightly, till you assemble the pavilion frame.

3

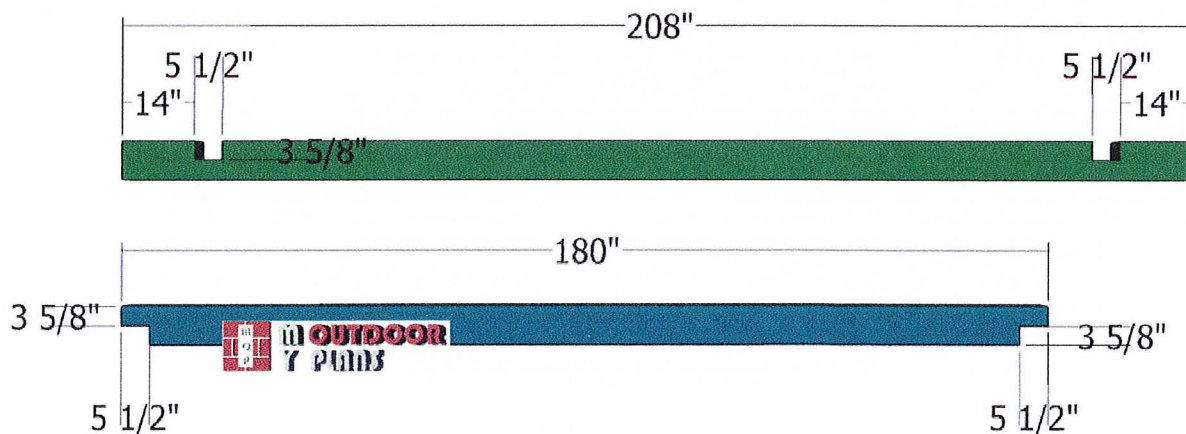

Use 6×8 lumber for the top rails. Mark the cut lines on the beams and then make the cut outs with a circular saw and a chisel. Set the circular saw at 3 5/8" and then make parallel cuts inside the marked areas. Clean the recess with a chisel and sandpaper.

4

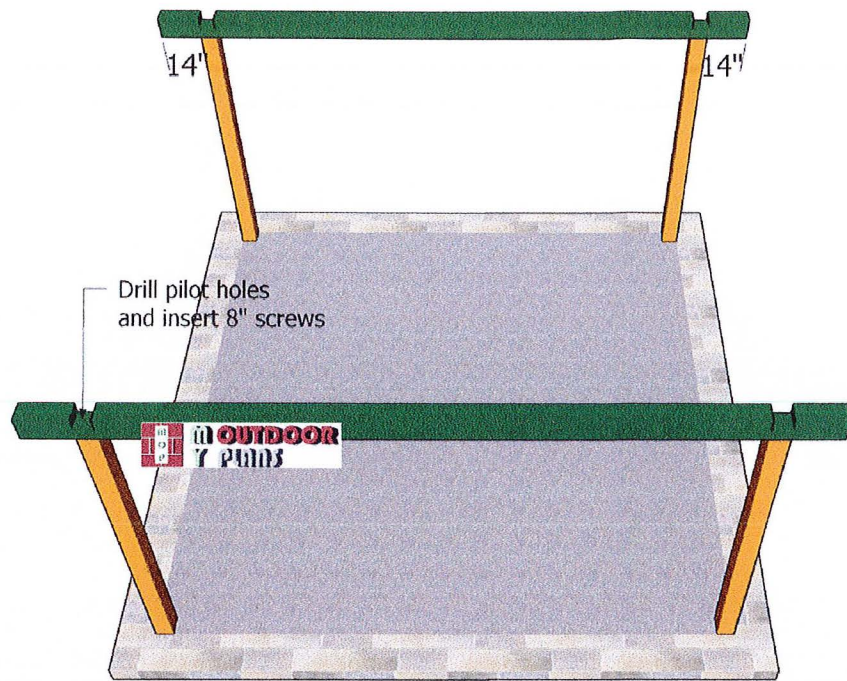

Fit the top rails to the sides of the pavilion. Notice the 14" overhangs to the front and back of the pavilion. Drill pilot holes through the plates and insert 8" screws to lock them to the posts. Use 2 screws for each joint. Make sure the corners are square and plumb the posts vertically.

5

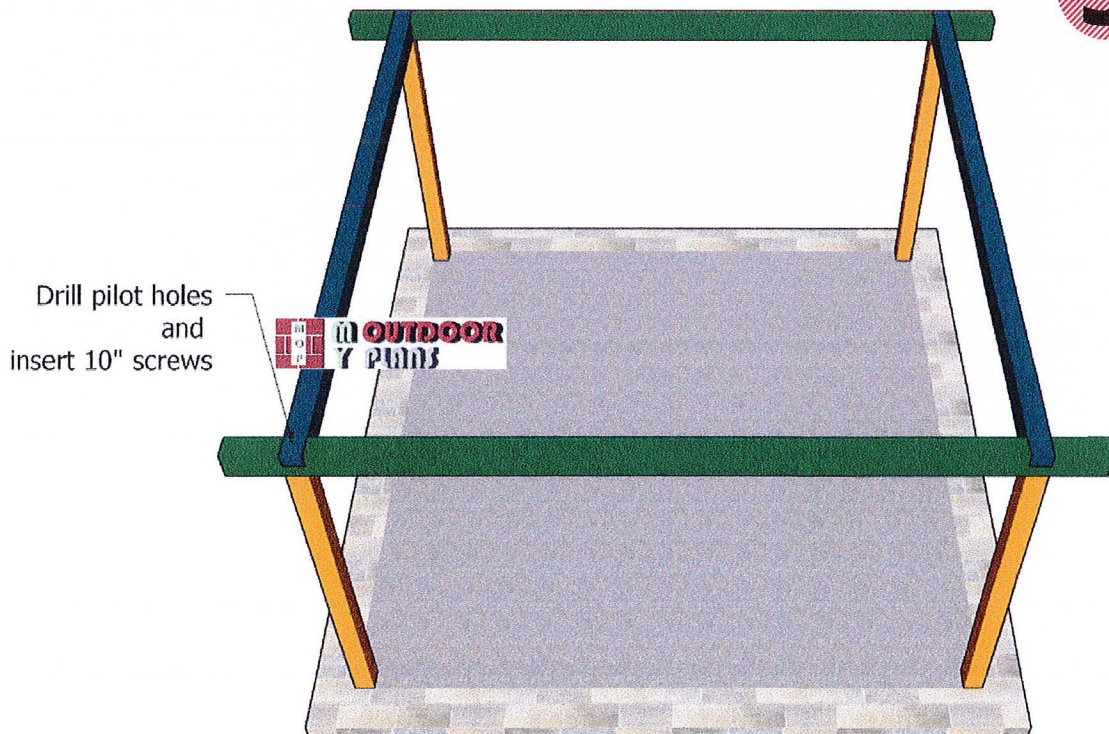

Fit the cross plates to the pavilion. Align the edges flush and drill pilot holes. Insert the 10" screws to lock the cross plates into place tightly.

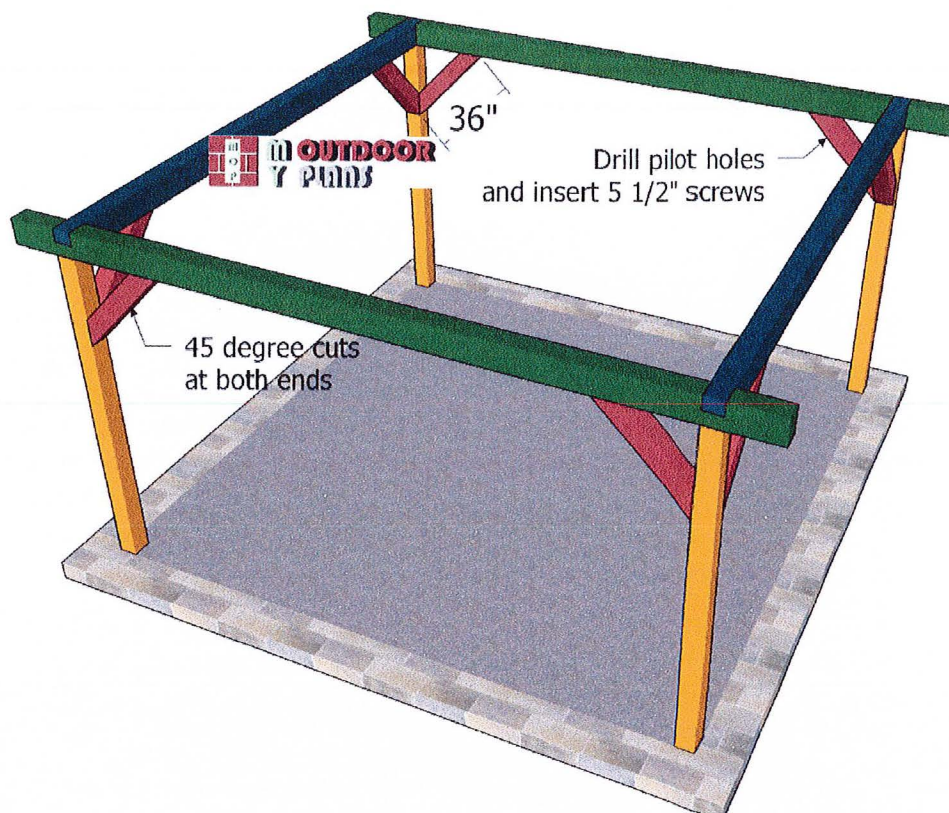

6

Build the braces for the front and back of the pavilion from 6×6 lumber. Use a miter saw to make 45 degree cuts to both ends of the braces. Fit the braces to the posts, after you plumb them vertically. Drill pilot holes and insert 5 1/2" screws to secure the braces into place tightly.

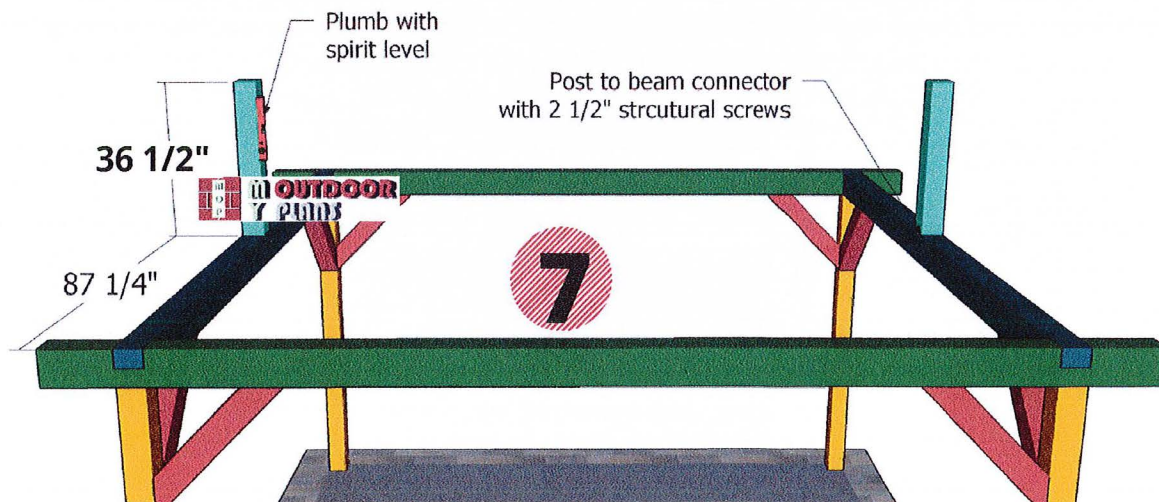

7

Center the 6×6 supports to the top of pavilion. Plumb the supports with a spirit level. Use post to beam connectors to secure the supports to the frame of the pavilion. Fit the ridge beam to the supports with post to beam connectors. Make sure the corners are square.

Use 2 1/2" structural screws to lock the connectors into place.

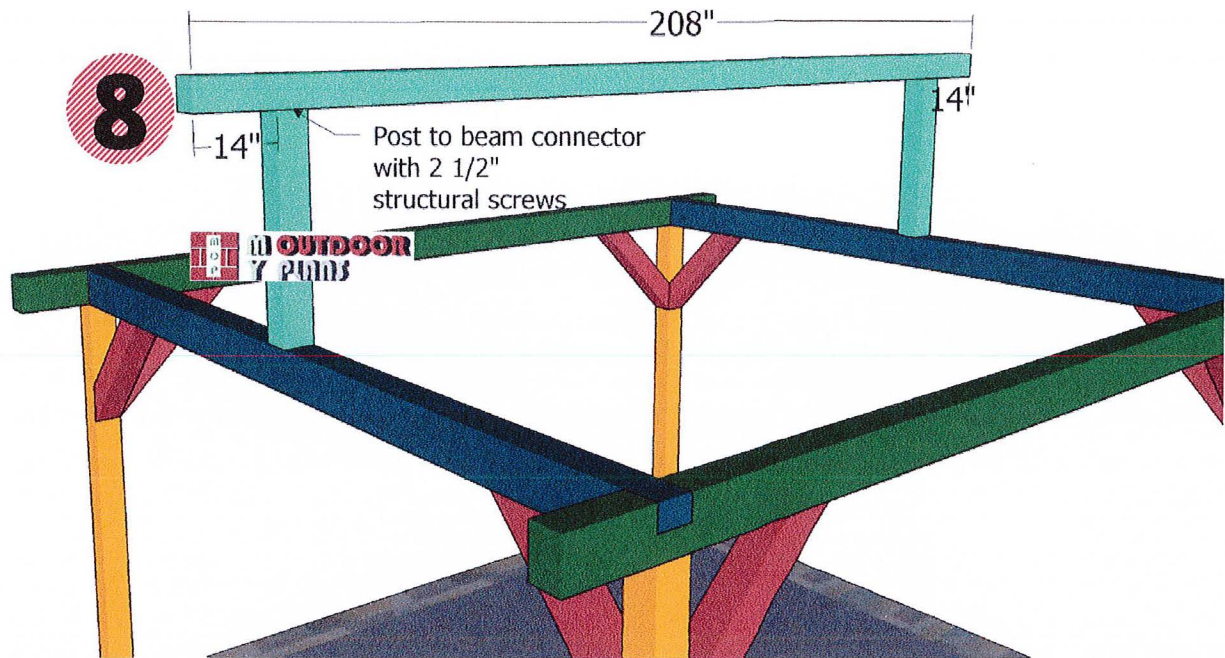

Fit the 6x8 ridge beam to the supports with post to beam connectors. Make sure the corners are square. Use 2 1/2" structural screws to lock the connectors into place.

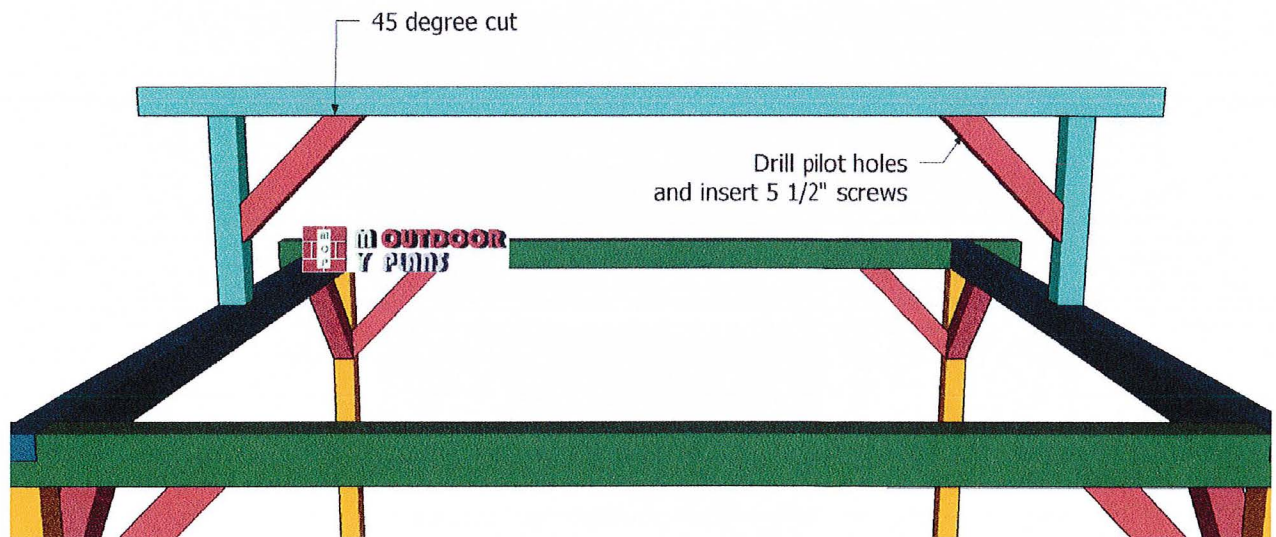

Use 6x6 lumber for the braces. Make 45 degree cuts at both ends of the braces. Secure the braces into place with 5 1/2" screws. Drill pilot holes before inserting the screws,

9

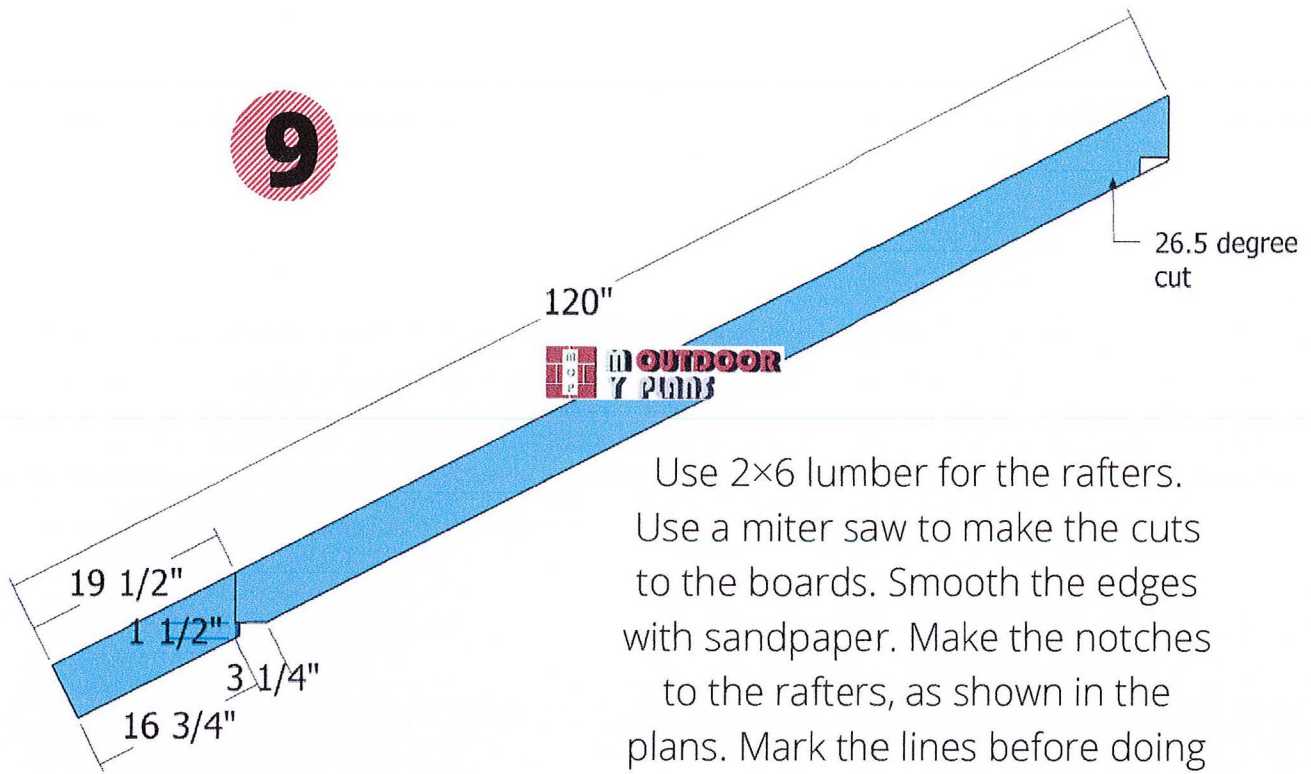

Use 2×6 lumber for the rafters. Use a miter saw to make the cuts to the boards. Smooth the edges with sandpaper. Make the notches to the rafters, as shown in the plans. Mark the lines before doing the cuts.

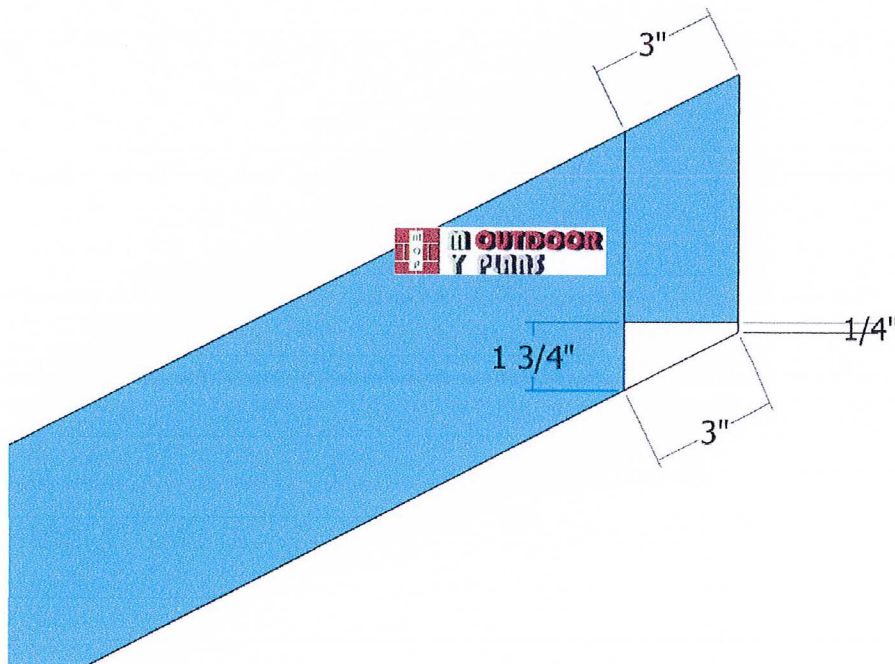

See a detail on how to cut the top end of the rafters.

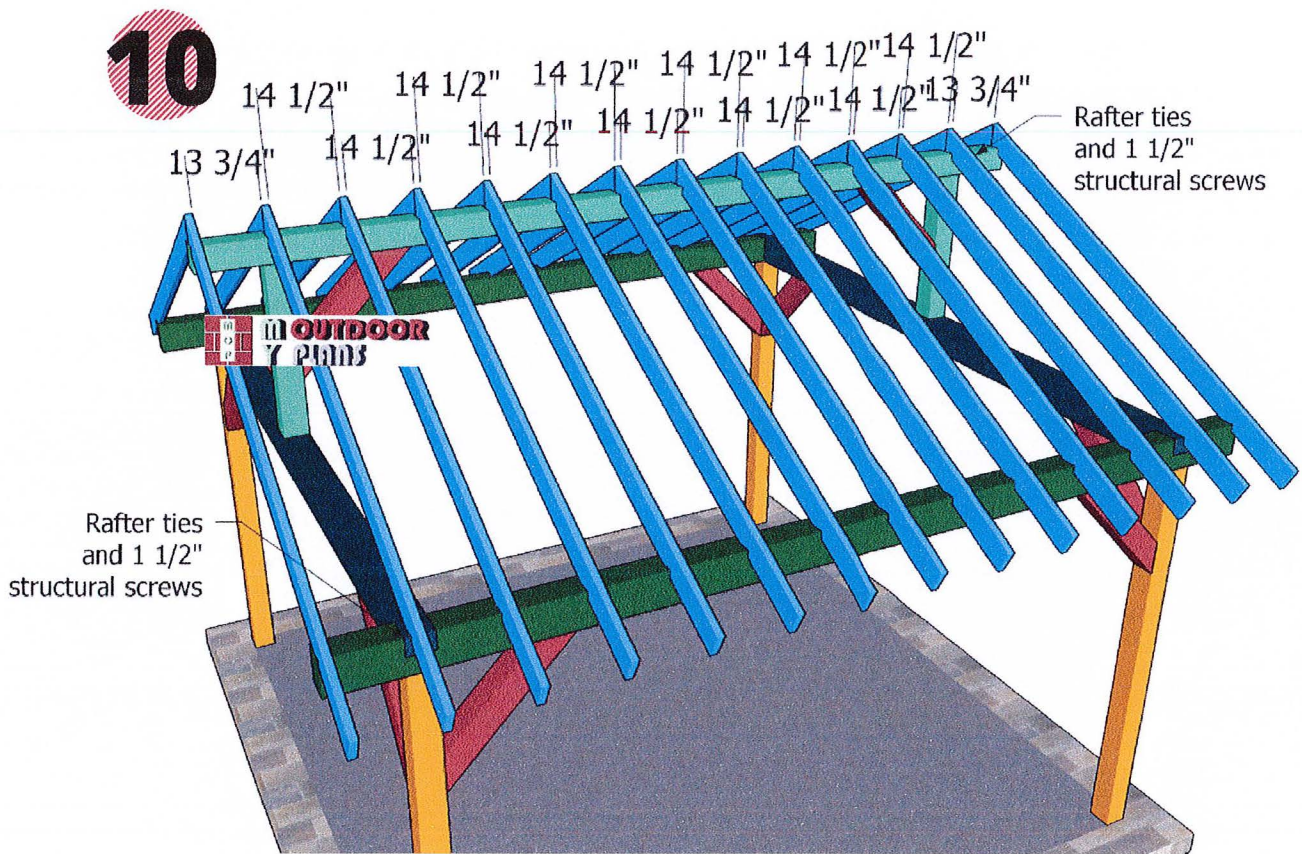

Fit the rafters to the top of the pavilion, using the information from the diagram. It is important to space the rafters properly (every 16" on center), otherwise you won't be able to attach the roofing sheets. Use rafter ties to lock the rafters to the beams. Use 1 1/2" structural screws for the rafter ties.

Use 3/4" plywood for the roof of the pavilion. Cut the sheets at the right dimensions and then lay them to the top of the pavilion. Leave no gaps between the sheets and then insert 1 5/8" screws, every 8" along the rafters, so you can secure them into place tightly.

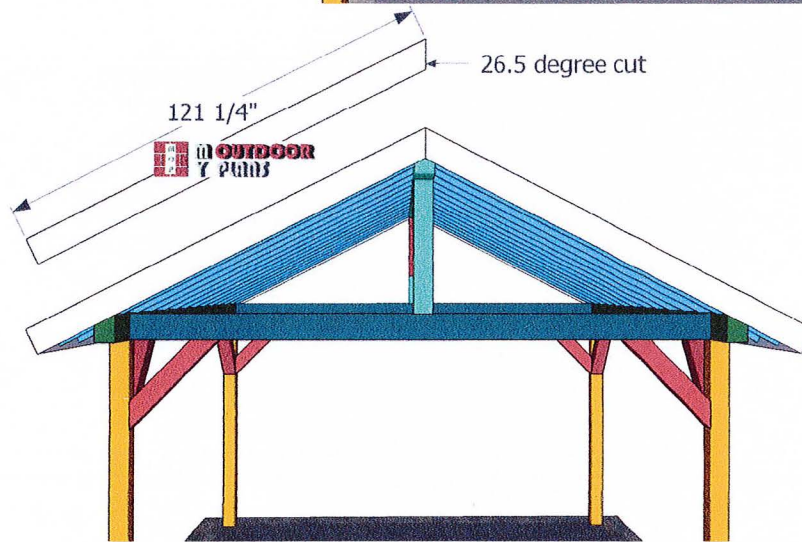
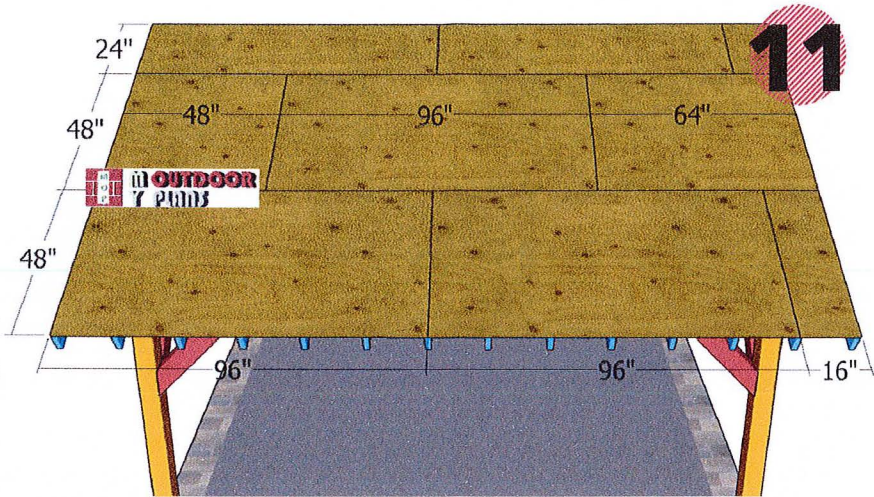

12

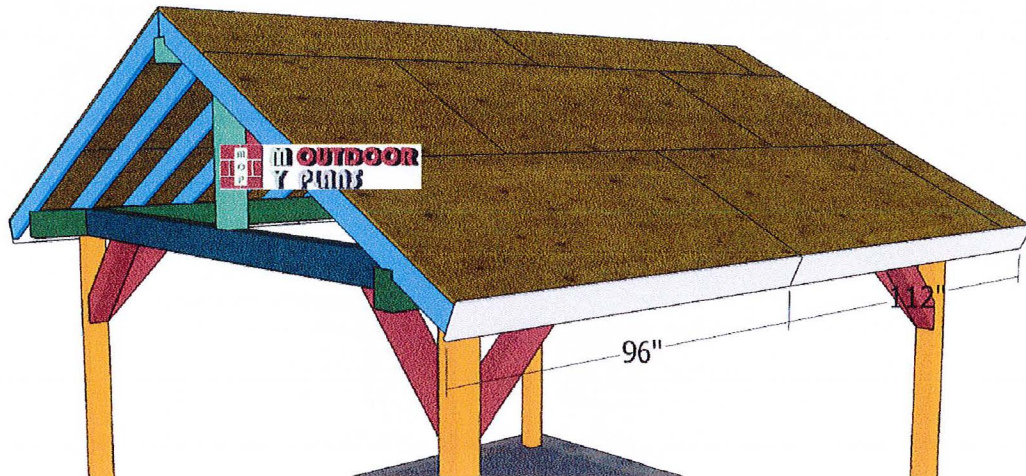

Fit 1×8 trims to the sides of the pavilion. Align the edges with attention and insert 2" nails to lock them into place tightly.
Fit the 1×8 trims to the front and back of the pavilion. Lock them into place with 2" nails.

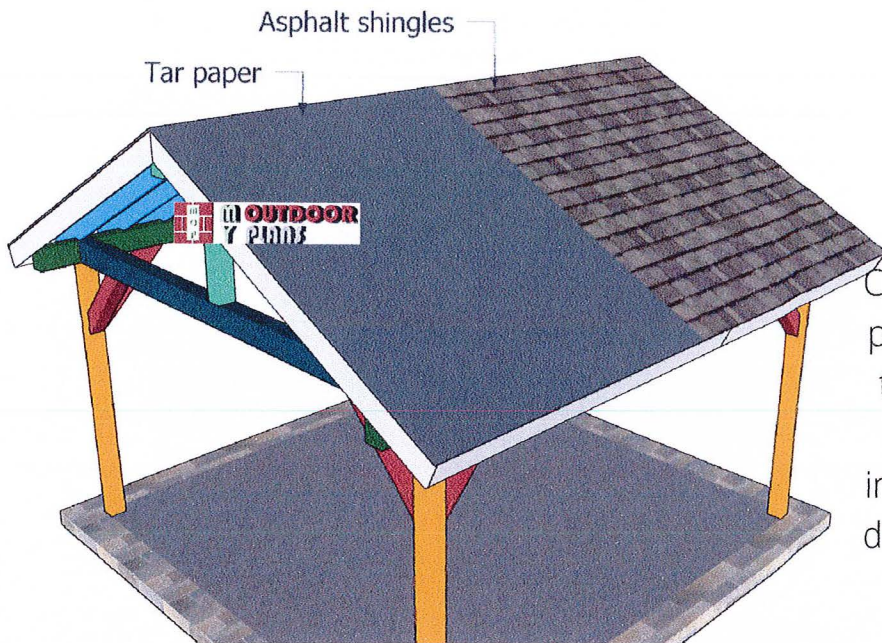

13

Cover the roof with tar paper and then install the asphalt shingles.

Make sure you also install the appropriate drip edges, so you can seal the shed roof.

Read the manufacturer's instructions for a tight fit.

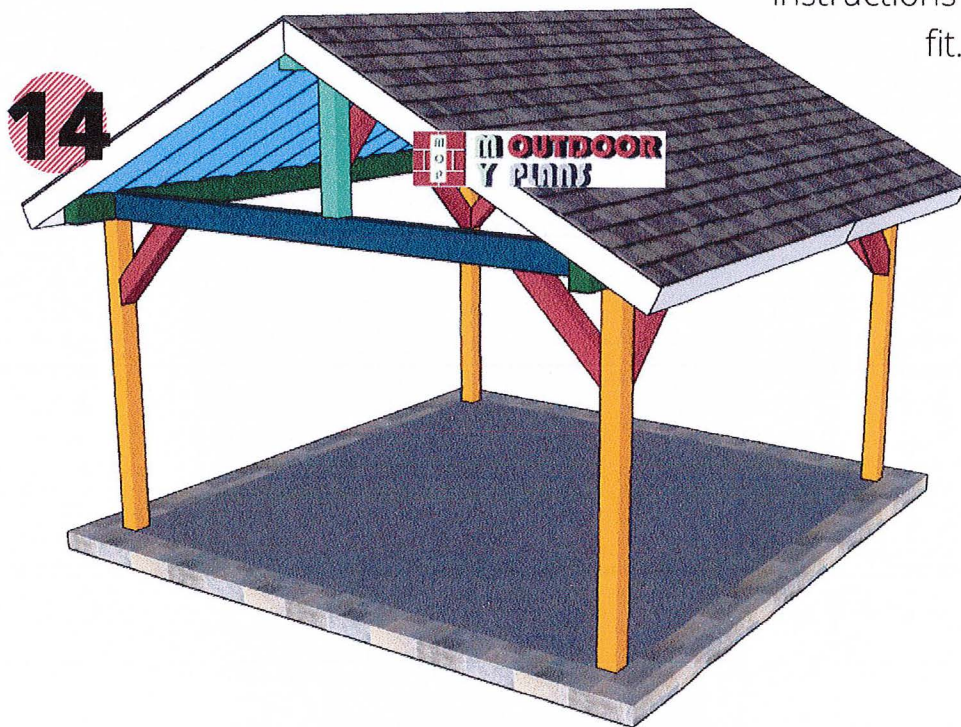

Last but not least, you need to take care of the finishing touches. Therefore, fill the holes with wood putty and then smooth the surface with 120-220 grit sandpaper.

Apply a few coats of paint / stain to enhance the look of the pavilion and to protect them from the elements.

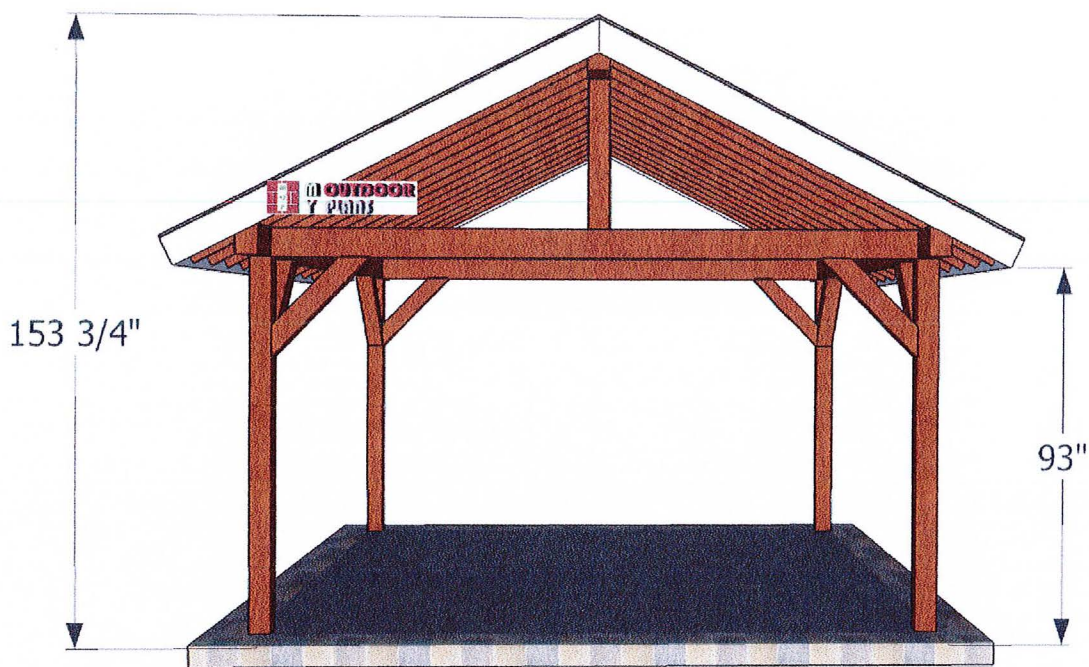

THANK YOU

I would love to see
your project.

To send a few pics

Click HERE

*In no event will MyOutdoorPlans.com or the its legal owners be liable for any loss, damage or injury arising from the use of information on this plan. You assume the full responsibility of your actions. For personal use only.

MORE PLANS AT:

MYOUTDOORPLANS.COM/SHOP

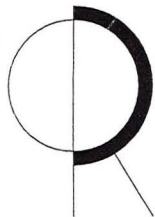

O'NEILL-RODAK
 LAND SURVEYING ASSOCIATES, P.C.
 LAND SURVEYORS - PLANNERS
 BOUNDARY CONSULTANTS
 FEMA ELEVATION CERTIFICATES
 ALTA/NSPS SURVEYS

MAP OF A SURVEY

LOT 53
 PENFIELD MEADOWS SUBDIVISION
 TOWN OF PENFIELD
 MONROE COUNTY, NEW YORK

5 SOUTH FITZHUGH STREET
 ROCHESTER, NY
 14614

PHONE (585) 325-7520 FAX (585) 325-1708
 e-mail surveyors@oneillrodak.com

CLIENT	CHRISTOPHER J. KOTARY, ESQ.		
SCALE	DATE	PROJECT NO.	
1" = 30'	08/24/2018	2018-1085	

REFERENCES:

CHICAGO TITLE INSURANCE COMPANY #1816-1988SCH DATED JULY 30, 2018
 LIBER 11292 OF DEEDS, PAGE 12
 LIBER 102 OF MAPS, PAGE 34

NOTES:

REFERENCE IS MADE TO A GAS MAIN EASEMENT GRANTED TO ROCH. GAS & ELEC. CORP.
 AS SET FORTH IN LIBER 2510 OF DEEDS, PAGE 369.

PARCEL TAX ID #139.11-3-17

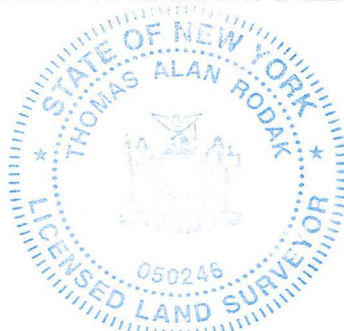

WE, O'NEILL-RODAK LAND SURVEYING ASSOCIATES, P.C., CERTIFY TO ESL FEDERAL CREDIT UNION, ITS SUCCESSORS AND/OR ASSIGNS; WEBTITLE AGENCY; MICHAEL A. BOCCUZZI AND ANNE DYRING RILEY LLC THAT THIS MAP WAS PREPARED FROM NOTES OF AN INSTRUMENT SURVEY COMPLETED AUGUST 23, 2018.

Thomas A. Rodak
 THOMAS A. RODAK, P.L.S. #050246

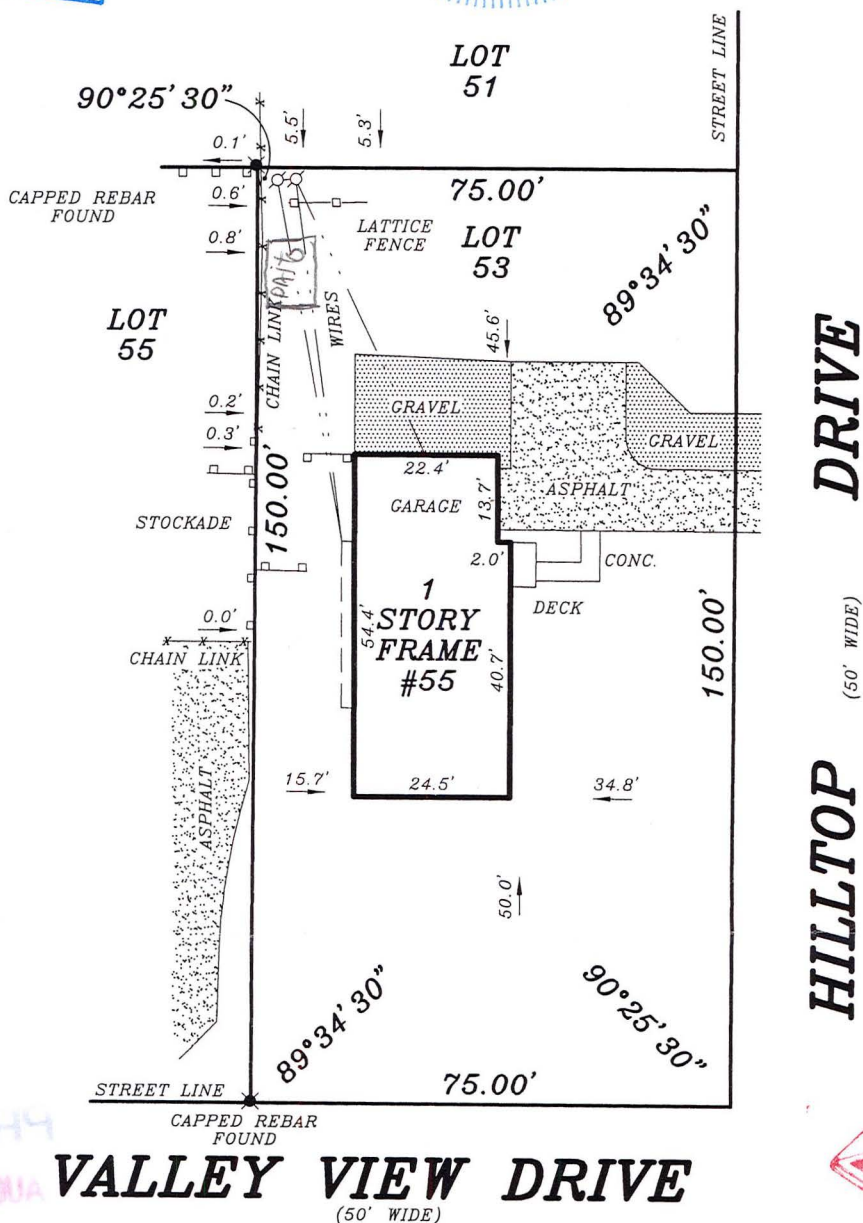

VALLEY VIEW DRIVE
 (50' WIDE)



"Unauthorized alteration of, or addition to, this survey map is a violation of section 7209 of the New York State Education Law"
 Copies of this survey map not bearing the land surveyor's inked or embossed seal shall not be considered to be a valid true copy.
 "Guarantees or certifications indicated hereon shall run only to the person for whom the survey is prepared, and on his behalf to the title company, governmental agency and lending institution listed hereon, and to the assignees of the lending institution.
 Guarantees or certifications are not transferable to the institutions or subsequent owners"

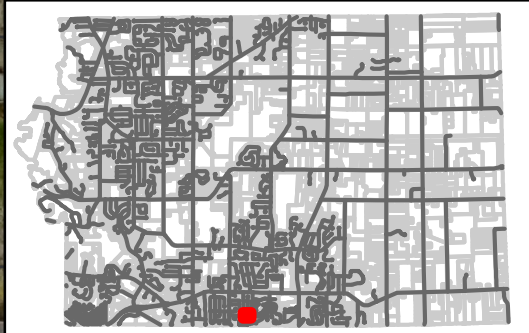
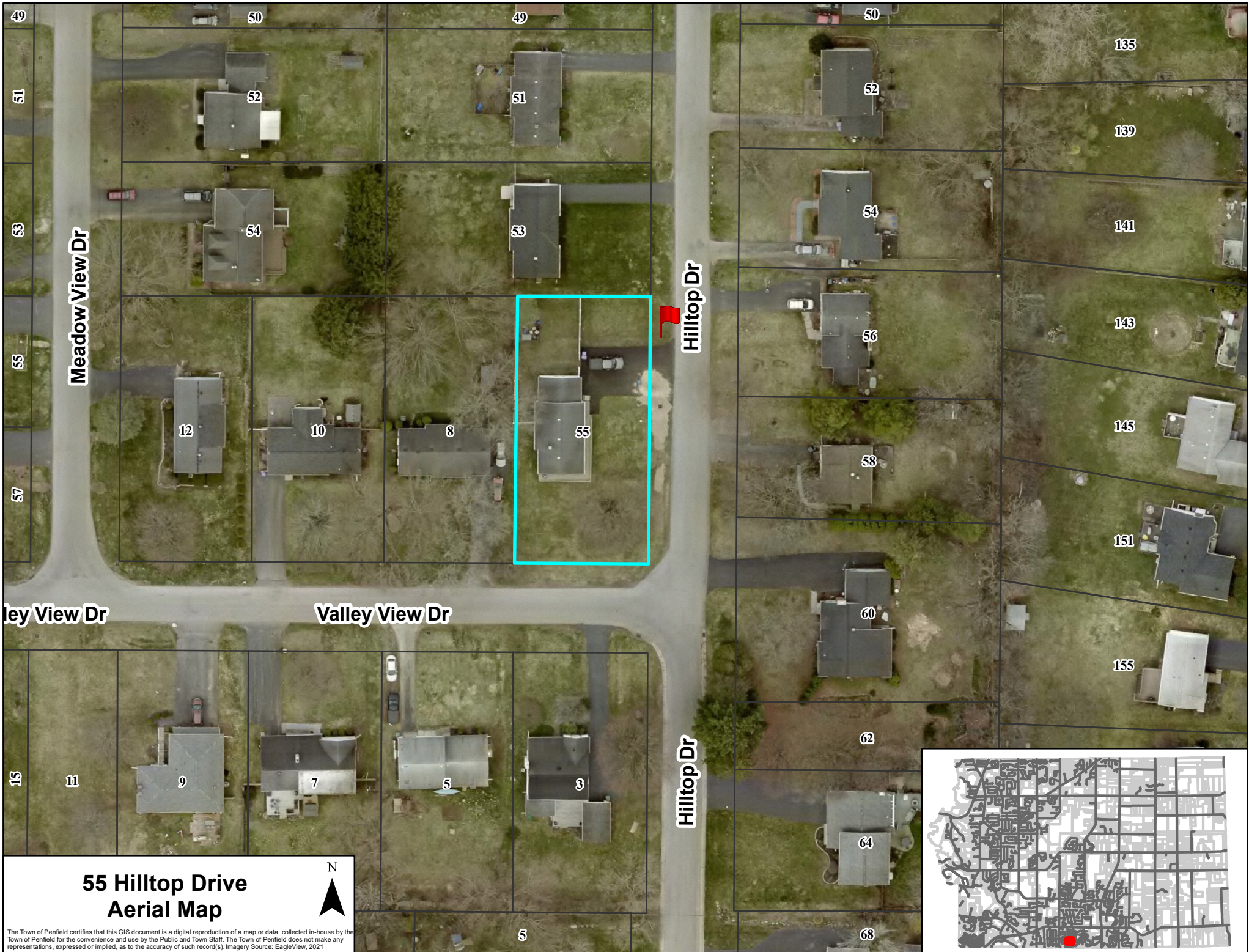

55 Hilltop Drive Aerial Map



The Town of Penfield certifies that this GIS document is a digital reproduction of a map or data collected in-house by the Town of Penfield for the convenience and use by the Public and Town Staff. The Town of Penfield does not make any representations, expressed or implied, as to the accuracy of such record(s). Imagery Source: EagleView, 2021